

KM-1301S_H(3)

STACKABLE ICE CUBER

Item # _____

Project: _____

Qty: _____

*AutoCad available on KCL

KM-1301S_H(3)

9/10

Item # 13232

KM-1301S_H(3)
48 x 27^{3/8} x 27^{3/8}

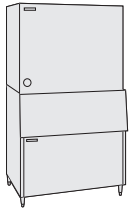

B-800

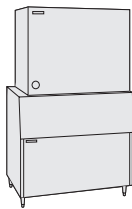

B-900

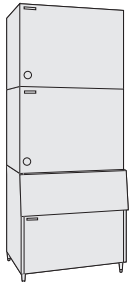

B-800

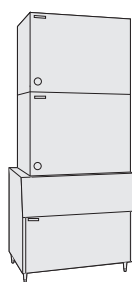

B-900

KM-1301SAH

Air-Cooled 1 Phase

KM-1301SAH3

Air-Cooled 3 Phase

KM-1301SWH

Water-Cooled 1 Phase
Shown on an optional
B-900

KM-1301SWH3

Water-Cooled 3 Phase



KM-1301SRH

Remote Air-Cooled 1 Phase

KM-1301SRH3

Remote Air-Cooled 3 Phase



- Up to 1353 lbs. of ice production per 24 hours
- Durable stainless steel exterior
- Protected by *HoshiGuard* Antimicrobial Agent 
- CycleSaver® design 
- EverCheck® alert system 
- Individual crescent cube
- Stainless steel evaporator
- Stackable for 2706 lbs. per 24 hour ice production in the same floor space
- Removable air filters (Air-cooled model only)
- R-404A Refrigerant
- Complies with California Energy Commission guidelines (CEC)

* The KM-1301SAH, KM-1301SAH3, KM-1301SRH and KM-1301SRH3 are ENERGY STAR qualified

Also available on Large Bins:

B-1150SS

B-1300SS

B-1500SS

B-1650SS



ISO 9001-5:2016

Warranty

Valid in United States, Canada, Puerto Rico, & U.S. Territories. Contact factory for warranty in other countries.

Three Year - Parts & Labor on entire machine.

Five Year - Parts & Labor on: Evaporator.

Five Year - Parts on: Compressor, air-cooled condenser coil.



© HOSHIZAKI AMERICA, INC.

618 Hwy. 74 S., Peachtree City, GA 30269

TEL 1-800-438-6087

FAX 1-800-345-1325

www.hoshizaki.com

Excell Marketing Group

KM-I30IS_H(3) STACKABLE ICE CUBER

DIMENSIONS
W x D x H
KM-I30IS_H(3)
48 x 27^{3/8} x 27^{3/8}

STACKABLE ICE CUBER

- Air-cooled 1 phase / Air-cooled 3 phase
- Water-cooled 1 phase / Water-cooled 3 phase
- Remote Air-cooled 1 phase / Remote Air-cooled 3 phase

AIR - COOLED 1 PHASE / AIR - COOLED 3 PHASE

Water Temp ° F.	50°	70°	90°
Air Temp ° F. 70°	1329 / 1298	1281 / 1257	1188 / 1162
Air Temp ° F. 80°	1292 / 1267	1217 / 1204	1109 / 1086
Air Temp ° F. 90°	1281 / 1257	1164 / 1159	1060 / 1049

WATER - COOLED 1 PHASE / 3 PHASE

Water Temp ° F.	50°	70°	90°
Air Temp ° F. 70°	1318 / 1333	1319 / 1323	1249 / 1246
Air Temp ° F. 80°	1319 / 1326	1321 / 1311	1211 / 1198
Air Temp ° F. 90°	1319 / 1323	1323 / 1300	1228 / 1201

REMOTE AIR - COOLED 1 PHASE / 3 PHASE

Water Temp ° F.	50°	70°	90°
Air Temp ° F. 70°	1353 / 1339	1315 / 1297	1219 / 1203
Air Temp ° F. 80°	1324 / 1307	1264 / 1243	1144 / 1127
Air Temp ° F. 90°	1315 / 1297	1222 / 1197	1110 / 1088

UTILITY CONSUMPTION

Model Number	Ice Production Per Cycle		KWH per 100 LBS.	Potable Water Gal. per 100 lbs.	Condenser Water Gal. per 100 lbs.
	Lbs.	Cubes			
KM-1301SAH	29.8	1440	4.5	15.7	N/A
KM-1301SAH3	30.4	1440	4.6	15.6	N/A
KM-1301SWH	31.0	1440	3.2	19.4	118
KM-1301SWH3	32.2	1440	3.4	19.1	119
KM-1301SRH	31.1	1440	4.1	16.6	N/A
KM-1301SRH3	30.7	1440	4.3	16.0	N/A

SPECIFICATIONS

Model Number	Condenser	Amperage	Min. Circuit Ampacity	Shipping Weight
KM-1301SAH	Air-Cooled	12.4	20	315 lbs.
KM-1301SAH3	Air-Cooled	9.5	20	315 lbs.
KM-1301SWH	Water-Cooled	8.2	20	315 lbs.
KM-1301SWH3	Water-Cooled	6.1	20	315 lbs.
KM-1301SRH	Remote Air-Cooled	13.5	20	315 lbs.
KM-1301SRH3	Remote Air-Cooled	10.7	20	315 lbs.

STORAGE BINS

Model Number	Application Capacity	ARI-Rated Capacity
B-800	800 lbs.	600 lbs.
B-900	900 lbs.	660 lbs.
B-1150	1150 lbs.	N/A
B-1300	1275 lbs.	N/A
B-1500	1490 lbs.	N/A
B-1650	1605 lbs.	N/A

ELECTRICAL & PLUMBING/KM-I30IS_H(3)

- KM-1301SAH / SVWH / SRH
 • 208 - 230V/60/1ø (3 wire with neutral for 115V)
 • 20 amp Max Fuse/HACR Breaker Size
 KM-1301SAH3 / SVWH3 / SRH3
 • 208 - 230V/60/3ø
 • 20 amp Max Fuse/HACR Breaker Size
 • 1/2" OD copper or equivalent independent potable water supply
 • 3/4" FPT independent drain connection



© HOSHIZAKI AMERICA, INC.

618 Hwy. 74 S., Peachtree City, GA 30269

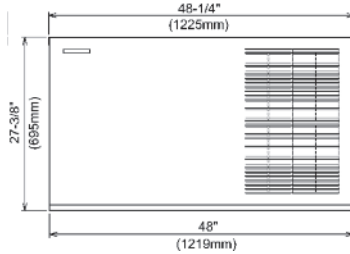

FRONT VIEW

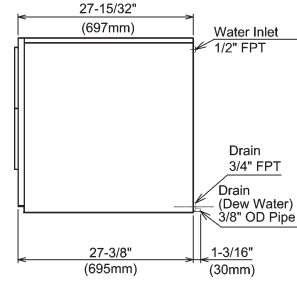

SIDE VIEW

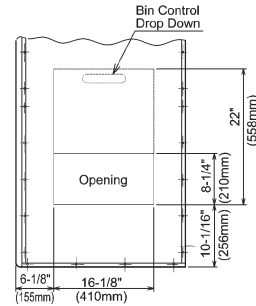

ICE DROP ZONE

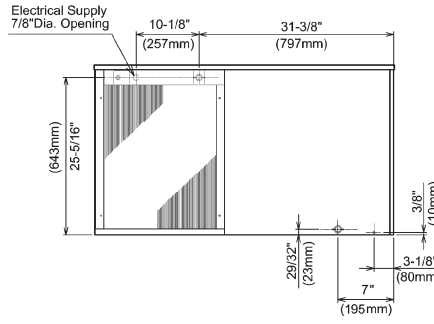

AIR-COOLED UNIT

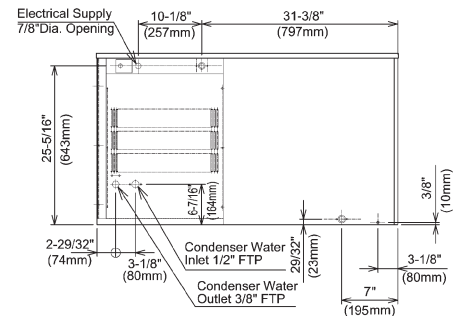

WATER-COOLED UNIT

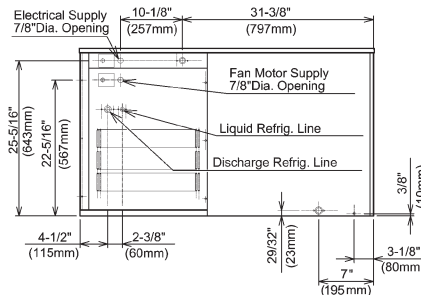

REMOTE AIR-COOLED UNIT

URC-14F Remote Condenser (Sold Separately)
 For Use with KM-1301SRH3

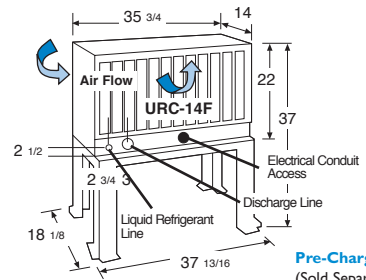

Pre-Charged Tubing Kits
 (Sold Separately)
 20' R404-2068-2
 35' R404-3568-2
 55' R404-5568-2

Voltage supply for the URC Remote Condenser is supplied from the Ice Maker. No additional circuit is required.

OPERATING LIMITS

- Ambient Temp Range 45 - 100°F
- Water Temp Range 45 - 90°F
- Water Pressure 10 - 113psig
- Voltage Range 187 - 253V

CONDENSING UNIT

- Voltage Range 104 - 127V
- Ambient Temp Range -20 - 122°F

SERVICE

- Panels easily removed and all components accessible for service.
- Removable/cleanable air filters (Air-cooled model only)

