



SPA-310 • SFA-291 Ice Dispensers

Model

- SPA-310 SFA-291

SPA Model

Designed for ice bucket filling in hotels, motels, and resorts

Ice only dispense, with coin-op and room card dispensing control options



Indigo Series 450 Ice Machine
SPA-310 Ice Dispenser

SFA Model

Designed for "large" container ice filling. Accepts up to 10.5" (26.67 cm) high container

Built-in water valve



Indigo Series 450 Ice Machine
SFA-291 Ice & Water Dispenser

Standard Features

- 180 lbs. (82 kgs.) ice storage capacity. Accepts 22" (55.88 cm) or 30" (76.2 cm) wide Manitowoc ice machine.
- Only 30" (76.2 cm) wide, 32" (81.28 cm) deep, and 82" high (208.28 cm).
- Patented rocking chute dispense mechanism reduces in-flight ice and ice spillage with quick on/off activation.
- Efficient built-in agitator assures 100% dispensing. Oversized drain pan collects larger quantity of ice overflow.
- DuraTech™ exterior provides superior corrosion resistance. Stainless finish with innovative clear-coat resists fingerprints and dirt.

Warranty

- 5-year parts and 5-year labor coverage on ice machine evaporator.
- 5-year parts and 3-year labor coverage on ice machine compressor.
- 3-year parts-and-labor coverage on all other ice machine and dispenser components.

Ice Shape



Half Dice
3/8" x 1 1/8" x 7/8"
(.95 x 2.86 x 2.22 cm)



Dice
7/8" x 7/8" x 7/8"
(2.22 x 2.22 x 2.22 cm)



QUALITY MANAGEMENT SYSTEM
CERTIFIED BY DNV
ISO 9001:2008



SPA-310 • SFA-291 Ice Dispensers

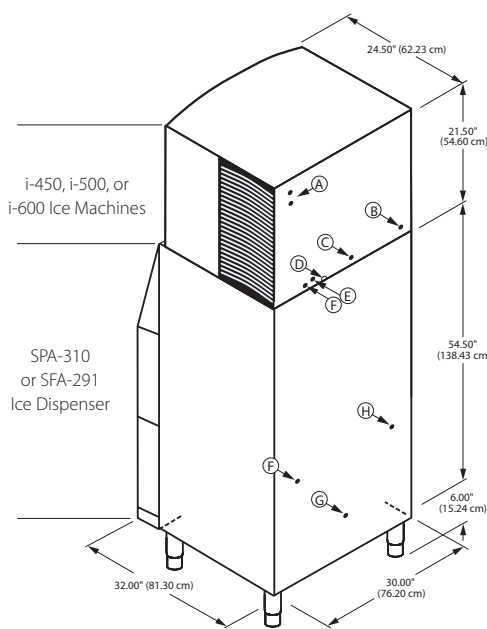

- A Electrical Entrance (2) Options
- B 3/8" (0.95 cm) F.P.T. Water Condenser Inlet (water-cooled units)
- C 1/2" (1.27 cm) F.P.T. Water Condenser Outlet (water-cooled units)
- D 3/8" (0.95 cm) F.P.T. Ice Making Water Inlet
- E 1/2" (1.27 cm) F.P.T. Ice Making Water Drain
- F Water Inlet: SFA-291 only
- G 1/2" (1.27 cm) F.P.T. Melting Tray Pan Drain Floor To Drain Distance = 13" (With 6" legs)
- H Dispenser Electrical Entrance

Installation Note - Dispensers have no minimum clearance, when installing an ice machine/ dispenser combination follow the clearance requirements for the ice machine being installed.

Ice Machine Electric

Note: Dispenser will accept single 22" or 30" wide ice machine.* Ice machine ordered separately. Choose Dice or Half Dice cube size. Refer to ice machine specification sheet for electrical and complete AHRI standard ratings.

Dispenser Electric:

115/60/1. (208-230/60/1 and 230/50/1 also available.)

Maximum Circuit Fuse Size:

15.0 amps. HACR-type circuit breakers can be used in place of fuses.

Dispenser Electrical Connection:

6' power cord, rated 125 VAC, 16-3 conductors with standard 3-prong, straight-blade, ground-type plug (NEMA configuration 5-15P).

Motor:

1.6 amps maximum. Permanently lubricated.

Service Access:

Dispenser door removes easily to access components.

Model Options:

SPA-310 push-for-ice rocking chute, SCA-330 coin-op and SRA-340 room card control available. To field-convert SPA-310 to SRA-340, call factory for information. SFA-291 has a water valve option.

*22" wide ice machines on 30" wide dispensers require K-00365 Adapter & K-00348 Baffle.

Series 300 (115 volt)

Model	Ice Shape	Ice Production 24 Hours			
		70°Air/50°F Water		90°Air/70°F Water	
		lbs.	kgs.	lbs.	kgs.
ID-0302A	dice	310	141	225	102
ID-0303W	dice	300	136	260	118
IY-0304A	half-dice	310	141	235	107
IY-0305W	half-dice	300	136	260	118

Series 500 (115 volt)

Model	Ice Shape	Ice Production 24 Hours			
		70°Air/50°F Water		90°Air/70°F Water	
		lbs.	kgs.	lbs.	kgs.
ID-0502A	dice	530	240	390	177
ID-0503W	dice	550	249	430	195
IY-0504A	half-dice	560	254	410	186
IY-0505W	half-dice	550	249	440	200

Series 450 (115 volt)

Model	Ice Shape	Ice Production 24 Hours			
		70°Air/50°F Water		90°Air/70°F Water	
		lbs.	kgs.	lbs.	kgs.
ID-0452A	dice	420	191	320	145
ID-0453W	dice	430	195	360	163
IY-0454A	half-dice	450	204	335	152
IY-0455W	half-dice	450	204	360	163

Series 600 (208-230 volt)

Model	Ice Shape	Ice Production 24 Hours			
		70°Air/50°F Water		90°Air/70°F Water	
		lbs.	kgs.	lbs.	kgs.
ID-0602A	dice	650	295	475	215
ID-0603W	dice	650	295	560	254
IY-0604A	half-dice	650	295	500	227
IY-0605W	half-dice	650	295	610	277

LumInIce™ Growth Inhibitor reduces yeast and bacteria growth for a cleaner ice machine.

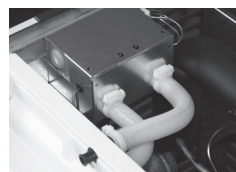

Options for SPA-310:



Room Card
SRA-340



Coin-Op
SCA-330
25-cent coin standard.